

Wavelength-Adaptation Underwater Optical Wireless Sensor Network Using Visible Light Communications

Xin Lin

Research and Development Division, Nakagawa Laboratories, Inc., Tokyo, Japan.

How to cite this paper: Xin Lin. (2020) Wavelength-Adaptation Underwater Optical Wireless Sensor Network Using Visible Light Communications. *Advances in Computer and Communication*, 1(1), 7-15. DOI: 10.26855/acc.2020.12.002

Received: September 20, 2020

Accepted: October 16, 2020

Published: October 29, 2020

***Corresponding author:** Xin Lin, Research and Development Division, Nakagawa Laboratories, Inc., Tokyo, Japan.

Email: linxin@optinformation.com

Abstract

A wavelength-adaptation underwater optical wireless sensor network (UOWSN) is proposed for marine environment development and seafloor resources observation. The method of LED-based visible light communication (VLC) is employed for creating the wireless network among the sensor nodes, and each sensor node is a VLC transceiver. The LED is incoherent source, it can neither damage the marine creatures like as a coherent laser source nor lose the inherent high speediness of light radiation yet. The wavelength-adaptation technique is used to adaptive control seawater turbidity and marine environment which both have spatiotemporal change. The effectiveness of proposed UOWSN is demonstrated in the experiments of underwater one-to-one image transmissions.

Keywords

UOWSN, VLC, Wavelength adaptation, LED

1. Introduction

A wireless sensor network (WSN) consists of multiple spatially distributed wireless terminals. Each wireless terminal is an autonomous sensor node. And each sensor node equipped with a wireless transceiver, a microprocessor, and a battery or energy harvesting device. The sensor nodes of a WSN are scattered in a specific physical space to collect information from these wireless sensors [1]. Figure 1 shows a mesh-type WSN. Because the WSN is a multipoint simultaneous measurement system, hence it is effective for grasping distribution changes of environmental situations and physical phenomena. And it is also one of core technologies used in current Internet-of-Things (IoT) system [2].

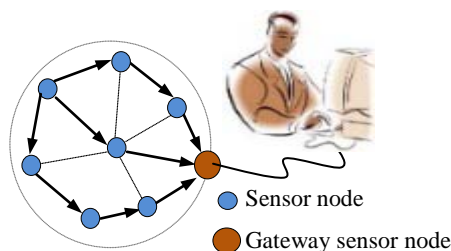
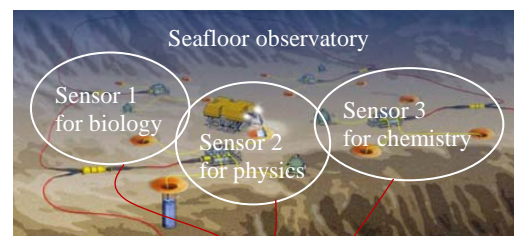

Figure 1. Mesh-type WSN.



Data in different fields

Figure 2. A detector net in a seafloor observatory.

On the other hand, the expansion of human activities in marine environments such as the monitoring and exploration of the ocean, offshore oil field exploration and so on make the needs for underwater WSN (UWSN) is increasing [3]. Like this that the developments of marine environment and resources have many tasks for the observations and analysis of many phenomena including marine physics, marine chemistry, marine biology, and so on. And data among these different fields are related to each other. Therefore, how to construct a smart UWSN is also interesting and important in the aquatic world with multi-data, so, data between different detectors can mutually use and reference. Figure 2 shows a detector net in a seafloor observatory.

However, the techniques of conventional terrestrial WSN to the marine environments have intrinsic difficulties. In fact, the major obstacle in using radio for underwater communication is the severe attenuation due to the conducting nature of seawater. In particular, the attenuation is very high for high-frequency radio waves and, since the current terrestrial technology for wireless communication is often based on high frequency in the order of Gbps, so it is practically impossible to use terrestrial techniques in underwater application.

In this paper, an underwater optical WSN (UOWSN) is proposed by using the visible light communication (VLC) technique. And the method of wavelength-adaptation control is used for seawater turbidity and marine environment which have the spatio-temporal change.

2. Underwater Optical WSN

An alternative to radio wave communication is using visible light wave. Seawater exhibits a window of reduced absorption in the visible spectrum, as shown in Figure 3 [4]. Particularly between 400-650nm, where water is relatively transparent to light and absorption takes its minimum value. Also, because the inherent high bandwidths and space segmentation of the light wave, make the techniques of underwater optical wireless communication (UOWC) the most important approach to construct the UWSN [5].

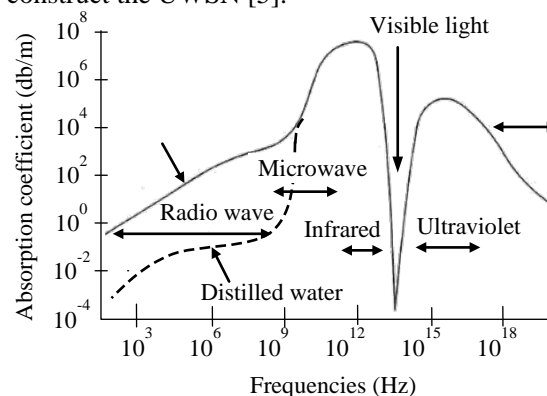

Figure 3. Absorption coefficients of electromagnetic wave in the water.

2.1 Underwater Optical Channel

Study of underwater optical channel is important for creating a UWSN. Figure 4 shows the physical model of visible light propagation in seawater.

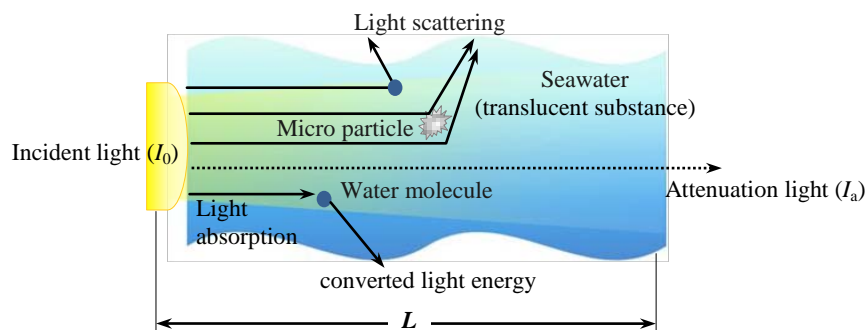

Figure 4. Physical model of light propagation in seawater.

Natural seawater is a translucent substance with a lot of micro particle and water molecule. The performance of the UOWSN relies on how well light propagates through this “translucent substance”. When incident light I_0 passes through the seawater, it become an attenuation light I_a after a propagation distance L due to absorption and scattering of micro particle and water molecule. The mathematical mode for this attenuation process can be written as

$$I_a(\lambda, L) = I_0(\lambda) \cdot \exp(-K(\lambda) \cdot L) \tag{1}$$

$$K(\lambda) = a(\lambda) + b(\lambda) \tag{2}$$

where λ is wavelength of the incident light, $K(\lambda)$ is total attenuation coefficient of seawater, $a(\lambda)$ and $b(\lambda)$ is the absorption and the scattering coefficient, respectively. The experimental data of $K(\lambda)$ in horizontal light propagation direction are given by Hulbert et al in 1945. Using these data, spectrum-intensity attenuations for different seawater types that correspond to Eq. (1) are obtained and plotted in Figure 5.

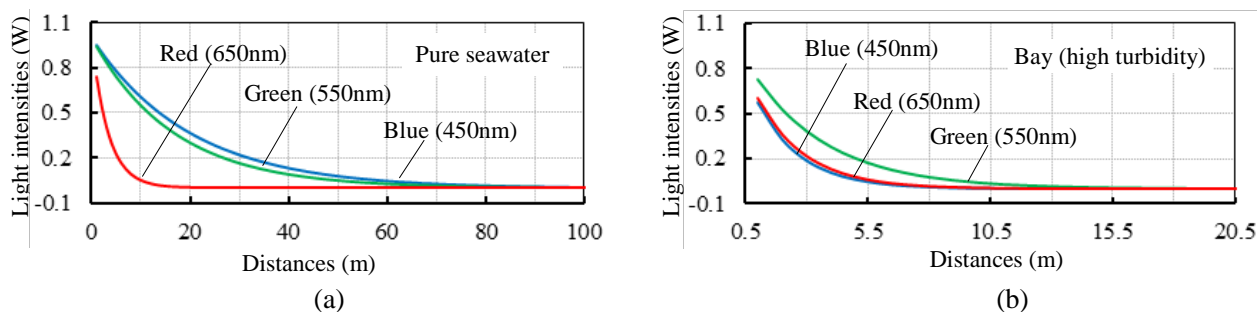

Figure 5. Spectrum-intensity attenuation for different seawater types in horizontal direction: (a) pure seawater and (b) bay.

For pure seawater type of Figure 5(a), the absorption is dominated almost by the attenuation of seawater molecule, the region of ideal wavelength with lowest attenuation for visible-light propagation is within the blue-green band between 400nm and 500nm. In case of high-turbidity bay of Figure 5(b), the total absorption in visible-light band is dominated by the combination of organic and inorganic particles, the ideal transmission wavelength is shifted from blue-green wave band towards green-yellow band around 550-600nm.

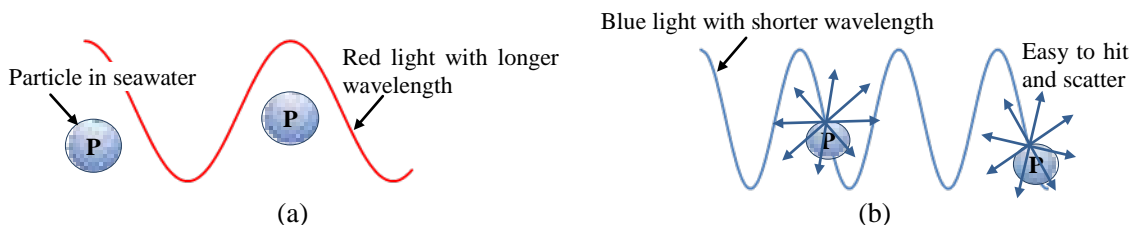

Figure 6. The influences of particles in seawater on visible light transmittance: (a) red light and (b) blue light.

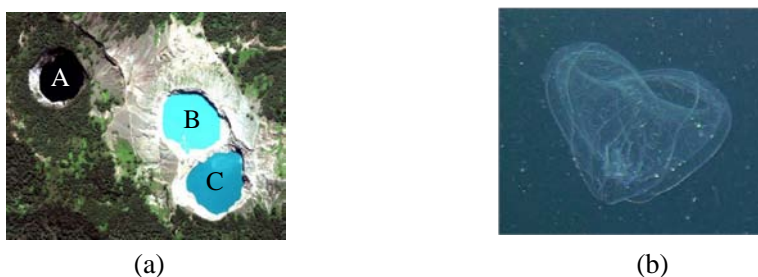

Figure 7. Noises in underwater optical channel: (a) spatiotemporal change of seawater color, it is an intrinsic noise (picture by Johnson, The Univ. of Warwick) and (b) marine snow in Sagami bay of Japan (picture by Kitamura, 2006).

Figure 6(a) illustrates the behaviours of particles in seawater when visible-light wave propagates in seawater. The particles are not easily hit by red light with long wavelength, as shown in Figure 6(a), but easily by blue light with short wavelength, as shown in Figure 6(b). When light wave hits a particle, its intensity will be attenuation because

scatter of light. That is why the red light with longer wavelength has better transmittance than blue light with shorter wavelength in high-turbidity seawater such as bay, as shown in Figure 5(b).

On the other hand, the spatiotemporal change of seawater color [Figure 7(a)] is also an intrinsic noise which can affect light propagation. And the marine snow [Figure 7(b)] in deep sea is an external noise which is able to disrupt the optical link because it is a visually observable enough large organic particulate.

2.2 Underwater Link Configuration

Underwater link configuration between sensor nodes, and what is the difference between underwater links and terrestrial links in a VLC system also should be considered. Typical underwater diffuseness link configurations between a transmitter and a receiver are tabulated in Table 1 [6].

Line of sight (LOS) refers to the ability to see the transmitter from the receiver. The LOS link is the simplest type which is a direct link between the transmitter (Tx) and receiver (Rx). Non-LOS link uses reflections from the sea surface to overcome underwater obstacles. LOS retroreflector link is useful when bidirectional communication is required, but the receiver is too low power to support a full transceiver for underwater sensor nodes. Theoretically, all these configurations have enough good bit error rate (BER) and are viable for short-range of under 15m underwater data transmission [7].

Table 1. Typical diffuseness links for UOWC

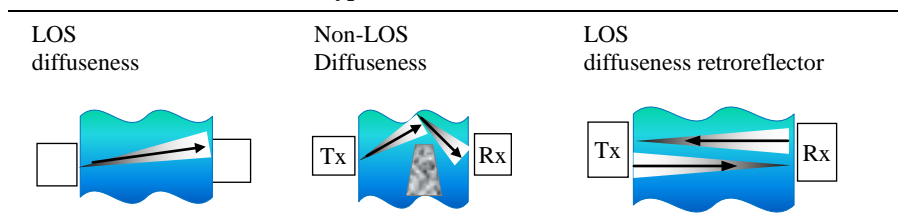

For turbid nature seawater, the attenuation of light propagation is dominated by scattering, a wide field-of-view (FOV) angle of transmitter can compensate for the increased attenuation. Incoherent visible-light LED (Light Emitting Diode) is most suitable for this diffuseness-link application.

2.3 Constructing an Adaptive UOWSN

Such as a WSN in terrestrial environment, a WSN in marine environment also has different types to favor different applications. Figure 8 shows link topologies of different UWSN types.

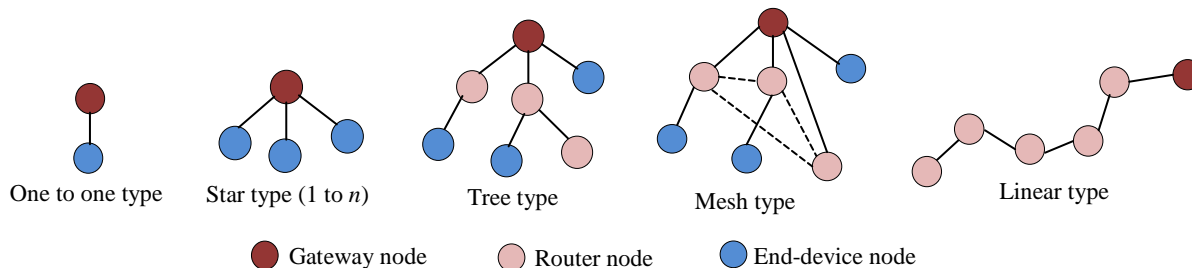

Figure 8. The link topologies of different UWSN type.

In order to construct a UOWSN which is viable to work in a seafloor observatory (see Figure 2), the mesh-type WSN topology is adopted to multipoint simultaneously measure and transmit data from different detectors and share these data each other without human operations. The wavelength-adaptation control technique [8] is used to help overcome the “spectrum-intensity attenuation” which is shown in Figure 5 in different seawater types. The links between sensor nodes are “LOS diffuseness” type configuration because it is easier to implement and most energy efficient for UOWC.

The UOWSN with mesh type that is proposed in this work is shown in Figure 9. It consists of one gateway sensor node (i.e., main node) and multiple sensor nodes (i.e., sub nodes). Each node is connected to other nodes to make a mesh; such, multiple communication paths can be generated, which cooperatively pass their data through the mesh network to the land-base station. The distances between the sensor nodes are about 3-10m. Data from each sensor

node are long-distance transmitted to a land-base station via the gateway node. The link between gateway node and land-base station is optical fiber.

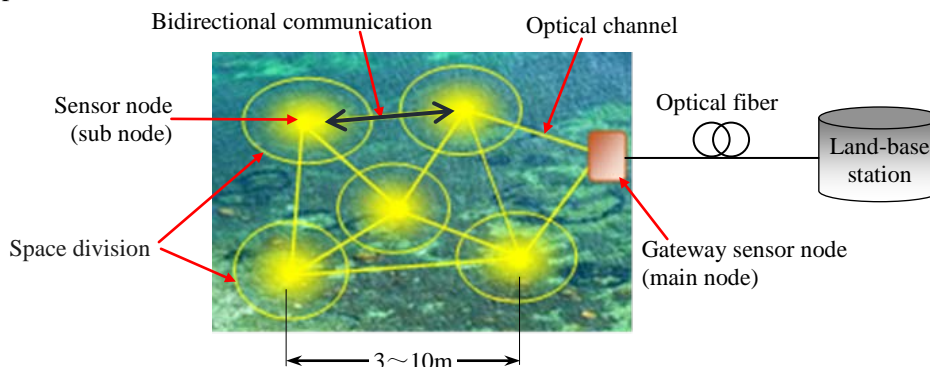

Figure 9. The mesh-type UOWSN.

Each sensor node is a wavelength-adaptation LED-based VLC transceiver, and its control principle as shown in Figure 10. Each VLC transceiver as a sensor node is installed into a seafloor detector for bidirectional data transmission. The links between these sensor nodes are optical seawater channels. The space division and visibility of visible light can ensure each sensor node is independent and identifiable both in space and time.

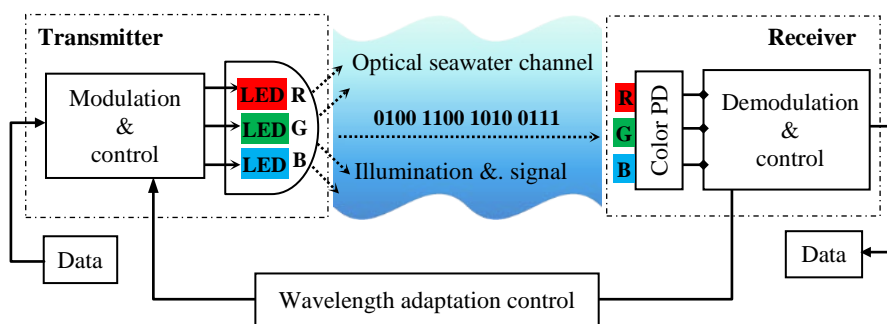

Figure 10. LED-based VLC transceiver with wavelength adaptation control.

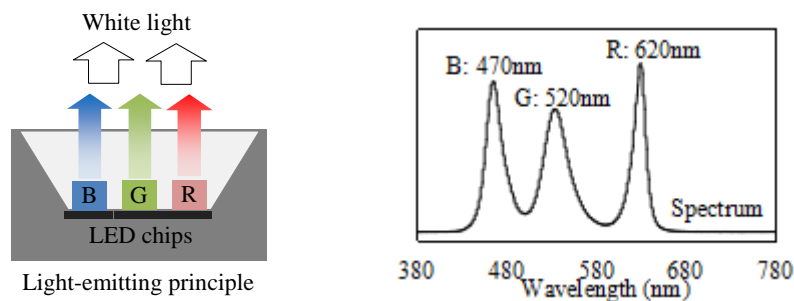

Figure 11. Three-chips white LED module.

In order to reach the wavelength-adaptation control, a multi-chip white LED is used as the light source of the transceiver. Figure 11 is a white LED module with three chips of R(red), G(green), and B(blue) which is used in this system. Each chip has an independent wavelength peak, which can as a separate channel for different seawater-types adaptation control. The LED is incoherent source, it can neither damage the marine creatures like as a coherent laser nor lose the inherent high speed of light yet. Also, it can as a lighting equipment for underwater lighting.

To detect three-colors light from LED source with high accuracy simultaneous, at receiving side of the transceiver, a photodiode (PD) with three-primary-colors sensor chips is used, as shown in Figure 12. Three sensor chips are arranged in mosaic shape on the light detection surface of PD.

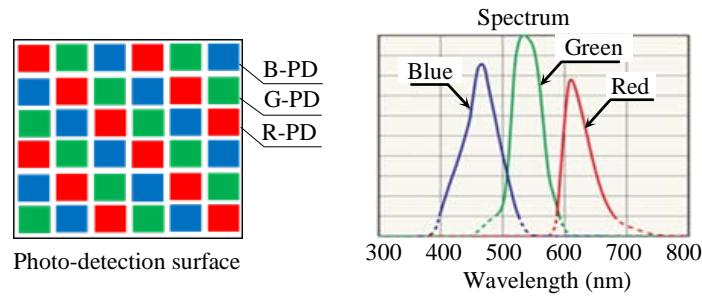

Figure 12. Three-sensors color photodiode.

The baseband intensity modulation is main carrier techniques employed in optical wireless communication. The on-off keying with no return to zero (OOK-NRZ) and the pulse position modulation with L levels (L -PPM) are two most common schemes of the baseband intensity modulation [9]. Figure 13 shows the coding methods of OOK-NRZ and 4-PPM ($L = 4$). The OOK-NRZ transmits data in a bit unit of binary “0” and “1”, and the 4-PPM transmits data in a symbol unit which is a string of 4 bits. Although OOK-NRZ scheme has higher data transmission rate, L -PPM yields an average power requirement that decreases steadily with increasing L . This decreased average power requirement makes L -PPM more suitable to underwater data transmissions. Especially, for deep-sea environment, more low power consumption is required.

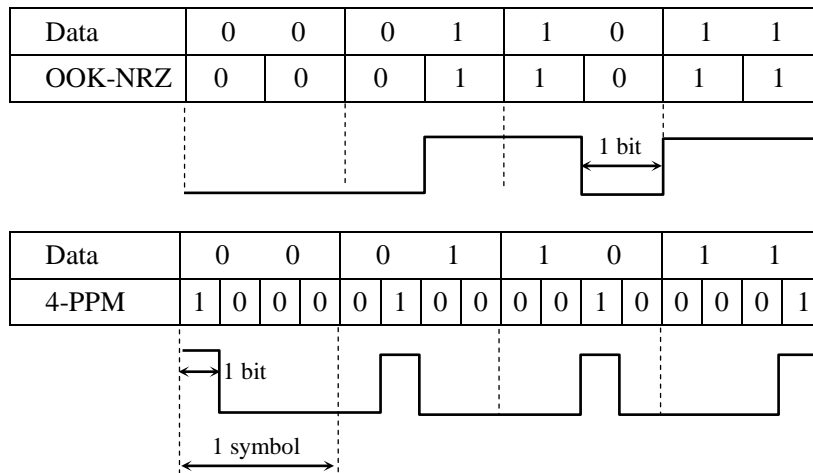

Figure 13. The coding methods of OOK-NRZ and 4-PPM.

The underwater digital optical wireless communication is employing binary encoding to accomplish optical data transmission and using BER parameter to describe the optical seawater channel performance. BER is a conditional probability; it must be averaged over the probability-density function of random digital signals to determine the unconditional BER. The BER of L -PPM given by

$$BER_{L-PPM} = \frac{L}{2} Q \left(\sqrt{\frac{L \log_2 L}{2}} \sqrt{SNR} \right) \tag{3}$$

$$Q(x) = \frac{1}{\sqrt{2\pi}} \int_x^\infty e^{-t^2/2} dt \quad (x \geq 0) \tag{4}$$

where SNR is the mean signal-to-noise ratio in the seawater channel and electronic circuit of communication system. By using Eq. (3) and (4), the SNR requirement of L -PPM scheme to reach a certain BER can be calculated and the BER performances for different L values are plotted in Figure 14.

The SNR requirement is decreased with increasing L , for example, to reach BER of 10^{-8} , the SNRs of $L = 2, 4, 8, 16$ are about 15, 9, 4.5, and 0.5, respectively. The larger L can obtain better BER performance. However, an increase in the L causes a decrease in the communication speed. $L = 4$ is a preferred value employed in common underwater

optical wireless communications due to 4-PPM scheme has appropriate efficiency both in BER and speed.

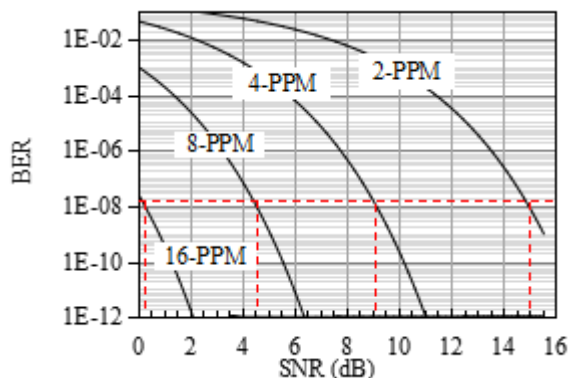

Figure 14. BER versus SNR for L -PPM with different L values.

3. Experiments and Results

Using the developed LED-based transceiver which shown in Figure 15, the experiment for underwater bidirectional image (640×480 pixels) transmissions is implemented between a one-to-one link. The principles of this transceiver have been described in Figures 10-12. The 4-PPM method is used for baseband light intensity modulation.

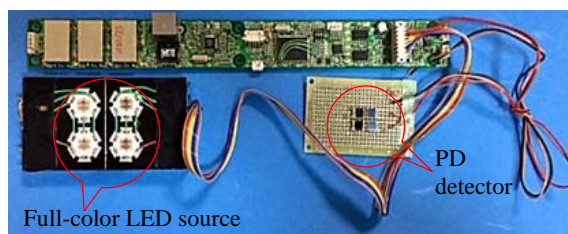

Figure 15. The prototype of LED-based VLC transceiver.

Figure 16 illustrates two work modes of system by using the transceiver in Figure 15. Figure 16(a) is a wired communication mode using a cross LAN (local area network) cable for TCP/IP communication with a fixed IP address, and Figure 16(b) is a wireless work mode via a wireless LAN hub.

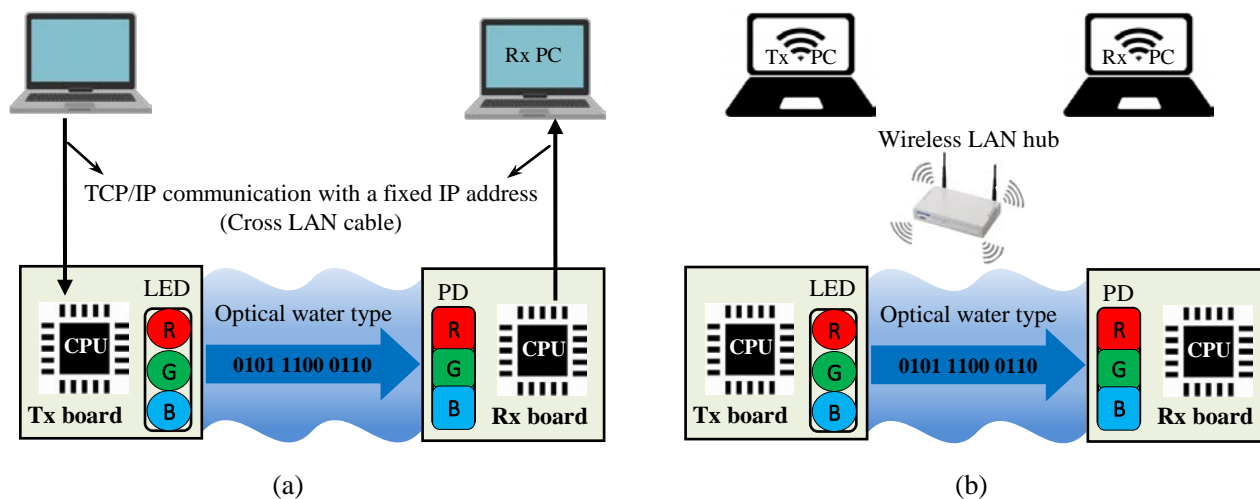

Figure 16. System work modes: (a) wired and (b) wireless mode.

The results of image transmission with different wavelength light are shown in Figure 17. In the experiment, the transceiver is placed in a transparent waterproof container which has high visible-light transmissivity of about 93%, and then, the waterproof container is placed into a water tank which has 600mm width. Turbidity of water at the tank is adjusted by using white-sand particles. A water-flow equipment is used to generate dynamic flow water which similar to natural water. The blue-green light at 490nm wavelength and green-yellow light at 590nm are used to demonstrate the data transmission effectiveness of the proposed wavelength-adaptation control method in lower- and higher-turbidity water. Stable data transfer rate is 5Mbps and BER less than 10^{-8} .

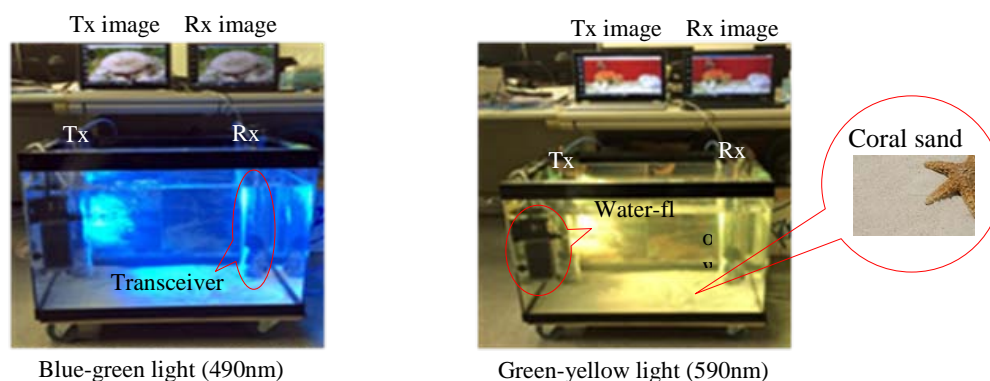

Figure 17. The results of underwater one-to-one image transmissions with different light wavelength.

4. Conclusions

The purpose of this study is to effectively develop marine environments and resources, and the incoherent LED is an attractive light source because it not only can transmit data and never damage the marine creatures, but also can as a lighting equipment for underwater lighting. So, by using the techniques of LED-based VLC, a mesh-type UOWSN with wavelength-adaptation-control function has been constructed for data transmission in aquatic environment. A prototype of LED-based VLC transceiver has been developed to perform the one-to-one image data transmission experiments with different light wavelength, and good BER and data rate have been obtained both in lower-turbidity and higher-turbidity water. Further studies include that:

- underwater optical experiments for one-to-many and many-to-one data transmissions.
- underwater link methods with low power consumption.
- vertical direction characteristics of optical seawater channel.

Acknowledgements

This work was supported by Ministry of Land, Infrastructure, Transport and Tourism, Japan.

References

- [1] Dargie, W., Poellabauer, C. (2010). *Fundamentals of wireless sensor networks: theory and practice*. Wiley.
- [2] Ootsuka, H., Kazama, H. (2014). A study of system integration related to advanced IT networks in IoT. *IEICE technical report*, 114(166), pp. 169-176.
- [3] Detweiller, C., Vasilescu, I., Rus, D. (2007). An underwater sensor networks with dual communications, sensing, and mobility. *OCEANS*, pp. 1-6.
- [4] Nakao, S. (1987). Attenuation of electromagnetic waves in seawater. *Defense Technology*, pp. 22-30.
- [5] Ghelardoni, L., Ghio, A., Anguita, D. (2012). Smart underwater wireless sensor networks. *IEEE 27th Convention of Electrical and Electronics Engineers in Israel*, pp. 1-5.
- [6] Johnson, L. J., Jasman, F., Green, R. J., Leeson, M. S. (2014). Recent advances in underwater optical wireless communications. *Underwater Technology*, 32(3), pp. 167-175.
- [7] Arnon, S. (2010). Underwater optical wireless communication network. *Optical Engineering*, 49, pp. 1-6.

- [8] Lin, X. (2017). Underwater wireless communication system of adaptation wavelength using visible light. *IEICE Trans. Fundamentals*, E100-A(1), pp. 185-193.
- [9] Manea, V., Dragomir, R., Puscoc, S. (2011). OOK and PPM modulations effects on bit error rate in terrestrial laser transmissions. *Telecomunicatii Anul LIV*, nr. 2, pp. 55-61.